

<p>Content:</p>  <p>ANT-5-4T (sensor) x1</p>	<p>Dimension:</p>  <p>*Dimensions in mm</p>
<p>1</p>  <p>Rotate the cover of the sensor counter-clockwise and remove it</p>	<p>2</p>  <p>Plug the sensor on the connecting base then rotate clockwise to tighten it</p>

EAN:	8719157040167	Detection Radius:	20% / 50% / 75% / 100% (1-8m)
Description:	Microwave Sensor for Noxion LED Highbay Ecowhite	Mounting Height:	Max 50ft. (15meters)
Operating Voltage:	12-24Vdc	Time Setting:	10s / 1min / 5min / 10min / 15min / 20min / 30min / 60min
Max. Current Sink:	50mA ± 5%	Light-Control:	24H/10LUX/30LUX/50LUX
HF System:	5.8GHz ± 75MHz	Temperature:	-4°F ~ +140°F (-20°C ~ +60°C)
Transmission Power:	<0.2mW	IP:	IP65
Dim Control Output:	0-10V		

INTRODUCTION

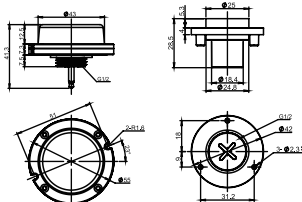
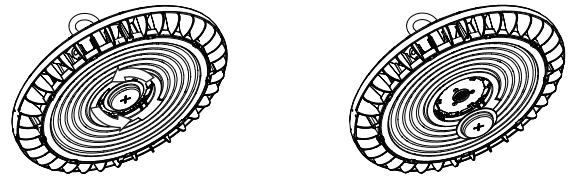
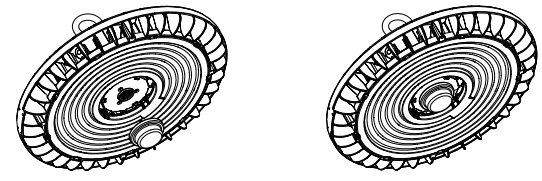

The ANT-5-4 is a motion sensor that dims lighting from high to low based on movement. This slim, low-profile sensor is designed for installation inside the bottom of a light fixture body. The sensors use microwave sensing technology that reacts to changes in movement within the coverage area. Once the sensor stops detecting movement and the time delay elapses lights will go from high to low mode and eventually to an OFF position if it is desired. Sensors must directly "see" motion of a person or moving object to detect them, so careful consideration must be given to sensor luminaire placement and lens selection. Avoid placing the sensor where obstructions may block the sensor's line of sight.

⚠ WARNING

- NOTE:** Warm up time is 15seconds. After the sensor connects input power first time, the light will keep on 15seconds, then go to dimming to work normally.
- NOTE:** Factory Default Setting: 100% sensitivity, Hold on time: 5min, Daylight sensor is ☀, Dimming level: 30%, Dimming time: 60minutes.
- NOTE:** Any setting changed by remote control, the led light that sensor connect will on/off as confirm.

Corridor Function

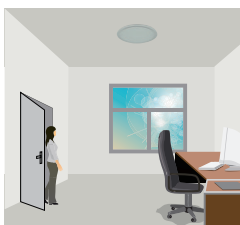
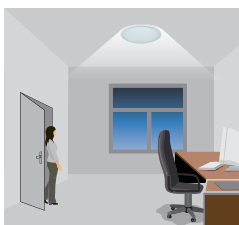
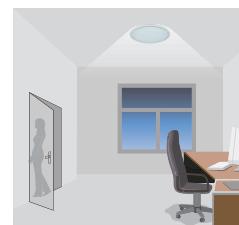
This function inside the motion sensor to achieve tri-level control, for some areas which require a light change notice before switch-off. The sensor offers 3 levels of light: 100%-->dimmed light (natural light is insufficient) -->off; and 2 periods of selectable waiting time: motion hold-time and stand-by period; Selectable daylight threshold and freedom of detection area.

 <p>With sufficient natural light, the light does not switch on when presence is detected.</p>	 <p>With insufficient natural light, the sensor switches on the light automatically when presence is detected.</p>	 <p>After hold-time, the light dims to stand-by level if the surrounding natural light is below the daylight threshold.</p>	 <p>Light switches off automatically after the stand-by period elapses.</p>
---	---	--	---

EN The luminaire shall be installed and maintained by a qualified electrician, in accordance with the national regulations in each country. The luminaire contains no replaceable parts. In case of the luminaire is damaged, it shall be exclusively replaced by the manufacturer or authorized dealer. Keep the operating manual for later use. The manufacturer is not responsible for the incorrect use and assembly of this product.

NL De armatuur dient te worden geïnstalleerd en onderhouden door een erkend installateur, in overeenstemming met de nationale regelgeving in het betreffende land. De armatuur bevat geen vervangbare onderdelen. Indien de armatuur is beschadigd dient deze enkel te worden vervangen door de fabrikant of door een erkende dealer. Bewaar de handleiding voor later gebruik. De fabrikant is niet verantwoordelijk voor onjuist gebruik en/of installatie van dit product.

DE Die Leuchte muss von einem qualifizierten Elektriker gemäß den nationalen Vorschriften in jedem Land installiert und gewartet werden. Die Leuchte enthält keine austauschbaren Teile. Falls die Leuchte beschädigt ist, wird sie ausschließlich durch den Hersteller oder den autorisierten Händler ersetzt. Bewahren Sie die Bedienungsanleitung für spätere Verwendung auf. Der Hersteller ist nicht verantwortlich für die unsachgemäße Verwendung und Montage dieses Produktes.

FR Le luminaire doit être installé et entretenu par un électricien qualifié, conformément à la réglementation nationale de chaque pays. Le luminaire ne contient pas de pièces remplaçables. Dans le cas où le luminaire est endommagé, il doit être remplacé exclusivement par le fabricant ou le revendeur agréé. Conservez le mode d'emploi pour une utilisation ultérieure. Le fabricant n'est pas responsable de l'utilisation et du montage incorrects de ce produit.

IT L'apparecchio deve essere installato e mantenuto da un elettricista qualificato seguendo le normative nazionali di riferimento. L'apparecchio non contiene parti sostituibili. In caso di rottura sarà sostituito esclusivamente dal produttore o da un rivenditore autorizzato. Conservate il manuale di installazione per eventuali utilizzi successivi. Il produttore non è responsabile per l'utilizzo ed il montaggio non corretto di tale apparecchio.

ES La luminaria debe de ser instalada y mantenida por un electricista cualificado, siguiendo las regulaciones nacionales de cada país. La luminaria contiene partes no reemplazables. En el caso de que la luminaria sea dañada, deberá ser reemplazada exclusivamente por el fabricante o distribuidor autorizado. Guarde el manual para usos posteriores. El fabricante no es responsable por el uso e instalación incorrecta de este producto.

Daylight Sensor Function

Open the daylight sensor by push  when remote control is in setting condition.

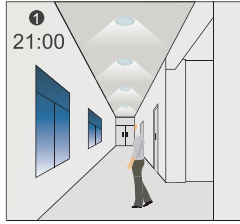

1
21:00
The light switches on at 100% when there is movement detected.

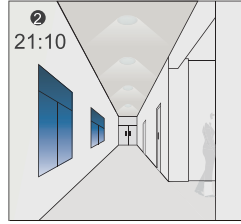

2
21:10
The light dims to stand-by level after the hold-time.

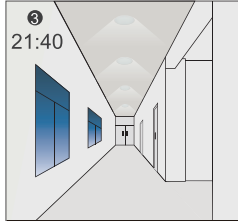

3
21:40
The light remains in dimming level at night.

Settings on this demonstration:
Hold-time: 30min
Setpoint on: 50lux
Setpoint off: 300lux
Stand-by Dim: 10%
Stand-by period: +∞
(when the smart photocell sensor open, the stand-by time is only +∞)

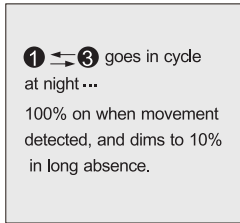

1 ↔ 3 goes in cycle at night ...
100% on when movement detected, and dims to 10% in long absence.

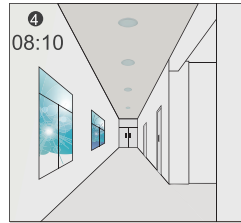

4
08:10
When the natural light level exceeds setpoint off to light, the light will turn off even if when the space is occupied.

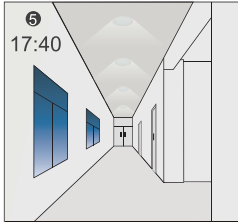

5
17:40
The light automatically turns on at 10% when natural light is insufficient (no motion).

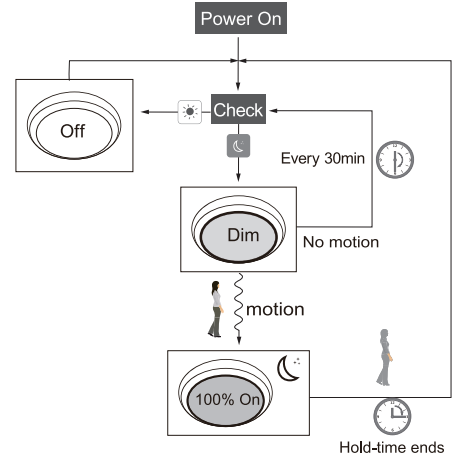

SENSOR COVERAGE

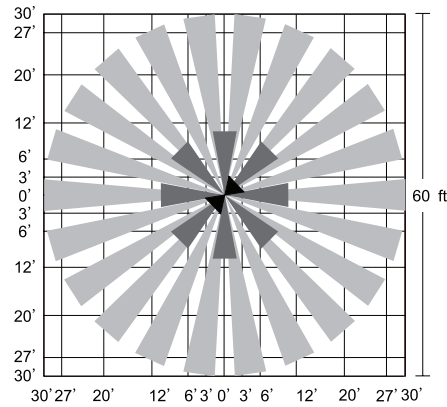
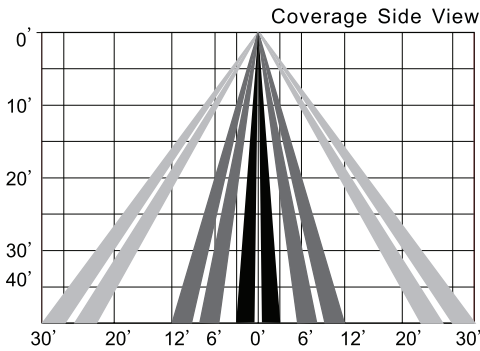

WIRING DIAGRAMS

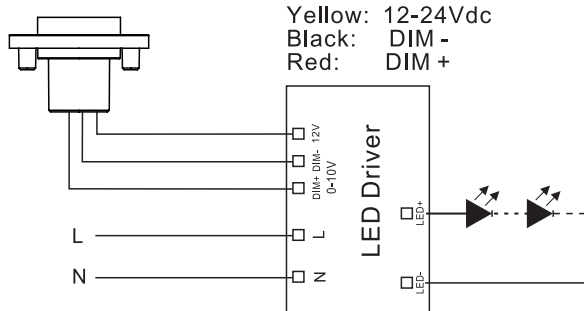

Yellow: 12-24Vdc
Black: DIM -
Red: DIM +

Cable specifications:
AWM 2464 22AWG 80°C 300V

Content:

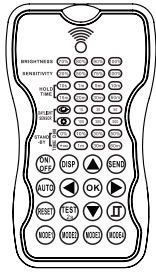

REMOTE
with carrying case

x1



x1

EAN	8719157040150
Description	Remote controller of microwave sensor for Noxion LED Highbay Ecowhite
Power Supply	2 x AAA 1.5V battery, Alkaline preferred
Carrying Case	RC-100 in carrying case
Upload Range	Up to 15m (50 ft.)
Op. Temperature	0°C ~ 50°C (32°F ~ 122°F)
Dimensions	123 x 70 x 20.3 mm (4.84" x 2.76" x 0.8")

⚠ WARNING

Remove the batteries from compartment if the remote will not be used in 30 days.

OVERVIEW

The remote control Wireless IR Configuration Tool is a handheld tool for remote configuration of IR-enabled fixture integrated sensors. The tool enables device to modify via pushbutton without ladders or tools, and stores up to four sensor parameter modes to speed configuration of multiple sensors.

The remote control uses bidirectional IR communication to send and receive sensor settings at mounting height up to 50 feet. The device can display previously established sensor parameters, copy parameters and send new parameters or store parameter profiles. For projects where identical settings may be desired across a large number of areas or spaces, this capability provides a streamlined method of configuration. Settings can be copied throughout a site, or in different sites.

LED INDICATORS

LED	DESCRIPTION	LED	DESCRIPTION
BRIGHTNESS	High end trim turning function(To Set the output level of connected lighting during occupancy)		To select the current surrounding lux value as the daylight threshold. This feature enables the fixture to function well in any real application circumstances.
SENSITIVITY	To set the occupancy sensing sensitivity of the Sensor		The daylight sensor stops working, and all motion detected could turn on the lighting fixture, no matter how bright the natural light is.
HOLD TIME	The time that the Sensor will turn off(if you choose stand-by level is 0) or dim the light to a low level after the area is vacated	STAND-BY DIM	To set the output level of connected lighting during vacancy. The sensor will regulate the lighting output at the set level. Setting the STAND-BY DIM level at 0 means light full off duringvacancy.
DAYLIGHT SENSOR	To represents various thresholds of natural light level for the Sensor .	STAND-BY TIME	To represents the time that the Sensor will keep the light at low dim level after the HOLD TIME elapsed.

BUTTON OPERATION

BUTTON	DESCRIPTION	BUTTON	DESCRIPTION
	Press the button, the light goes to permanent on or permanent off mode, and the sensor is disabled. (MUST press button to quit this mode for Setting.		Press button, the sensor starts to function and all settings remain the same as the latest status before the light is switched on/off.
	Display the current/latest setting parameters in LED indicators(the LED indicators will on for showing the setting parameters).		The button is for testing purpose sensitivity only. after you choose sensitivity thresholds, then you press button, The sensor goes to test mode(hold time is only 2s) automatically ,meanwhile the stand-by period and daylight sensor are disabled. Press button to quit from this mode.
	Press button, all settings go back to settings of dip Switch in sensor.		
	Enter in the setting condition, the parameter leds of remote control will flash to be selected. and Navigate to UP and Down for choose selected parameters in LED indicators.		Navigate to LEFT and RIGHT for choose selected parameters in LED indicators.
	Confirm the selected parameters selected parameters in remote control.		Open and close smart daylight Sensor. Press Enter in the setting condition, the parameter leds of remote control will flash to be selected, Press for open or close smart daylight Sensor.
	Press button, upload the current parameters to sensor(s), the led light which the sensor connects will on/off as confirm.		
	4 Scene modes with preset parameters which are available to be changed and saved in modes.		

SETTING

The SETTING Content contains all available settings and parameters for remote sensors. It allows you to change the available control, parameters, and operation of the sensor from factory default or current parameters.

Change multiple settings of sensor(s)

1.Press button, the remote control leds will show the latest parameters you set.

NOTE: if you push button before, you must push button to unlock the sensor.

2.Press enter in the setting condition, the parameter leds of remote control will flash to be selected, navigate to the desired setting by pressing to select the new parameters.

3.Press ok to confirm all setting and saving.

4.Aim at the target sensor and press to upload the new parameter, the led light which the sensor connects will on/off as confirm.

NOTE: the setting works key step is by Push , enter in the setting condition.

NOTE: the led light which the sensor connects will on/off after getting the new parameter as confirm.

NOTE: If you press button, the remote led indicators will show the latest parameters which were sent.

Change multiple setting of sensors with smart photocell sensor Open

- .Press **DISP** , the remote led indicators will show the latest parameters.
- .Press **▲** or **▼** enter in the setting condition, the parameter Led indicators of remote control will flash to be selected.
- .Press **□**, 2 led indicators will flash in daylight sensor settings ,select daylight **10** **30** **50** as setpoint to light on Automatically , select daylight **100** **300** **500** as setpoint to light off Automatically.
- .Press **OK** to confirm all setting and saving.
- .Aim at the target sensor and press **SEND** to upload the new parameter. The led light which the senso connects will on/off.

OTE: **□** is disabled by default.

- .Open or close the smart daylight sensor by push **□** when remote control is in setting condition.
- .When the smart daylight sensor open, 2 Led indicators are flash in daylight sensor setting. select daylight **10** **30** **50** as setpoint to light on Automatically , select daylight **100** **300** **500** as setpoint to light off automatically. When smart daylight sensor close, 1 Led indicator is flash in the daylight sensor setting for choose daylight sensor threshold.
- .When the smart daylight sensor open, the stand-by time is only **+∞** .
- .Smart daylight sensor takes place of normal photocell sensor and works independently.
- .See **Daylight Sensor Function**.

Corridor Function

This function inside the motion sensor to achieve tri-level control, for some areas which require light change notice before switch-off. The sensor offers 3 levels of light: 100%-->dimmed light (natural light is insufficient)-->off; and 2 periods of selectable waiting time: motion hold-time and stand-by period; Selectable daylight threshold and freedom of detection area.

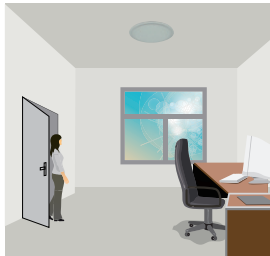

With sufficient natural light, the light does not switch on when presence is detected.

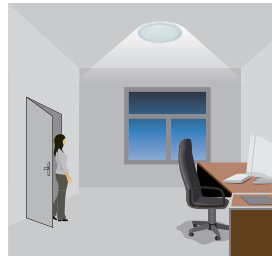

With insufficient natural light, the sensor switches on the light automatically when presence is detected.

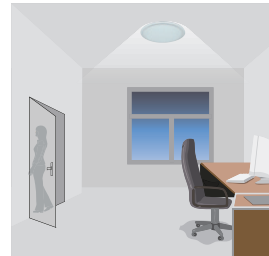

After hold-time, the light dims to stand-by level if the surrounding natural light is below the daylight threshold.

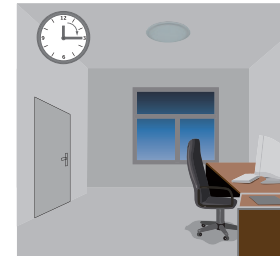

Light switches off automatically after the stand-by period elapses.

Daylight Sensor Function

Open the daylight sensor by push **□** when remote control is in setting condition.

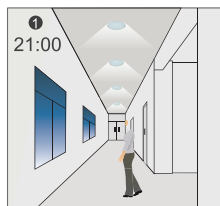

The light switches on at 100% when there is movement detected.

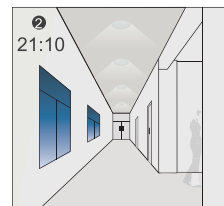

The light dims to stand-by level after the hold-time.



The light remains in dimming level at night.

Settings on this demonstration:

- Hold-time: 30min
- setpoint to light on: 50lux
- setpoint to light off: 300lux
- Stand-by Dim: 10%
- Stand-by period: +∞
- (when the smart photocell sensor open, the stand-by time is only +∞)

1 → 3 goes in cycle at night...
100% on when movement detected, and dims to 10% in long absence.

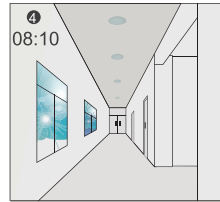

When the natural light level exceeds setpoint off to light, the light will turn off even if when the space is occupied.

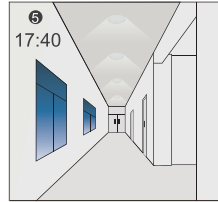

The light automatically turns on at 10% when natural light is insufficient (no motion).

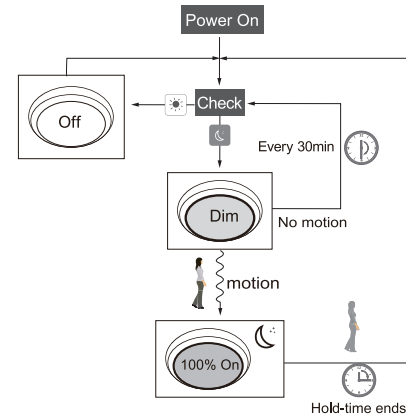

Corridor Function VS Daylight Sensor Function.

1. In corridor function, turn on the light MUST by natural light level lower daylight sensor setting and Occupancy. In smart daylight sensor function, turn on the light by natural light level lower daylight setpoint to light on even if vacancy.
2. In corridor function, turn off light by stand-by time finish if vacancy. In smart daylight sensor function, turn off the light by natural light level higher than daylight setpoint to light off even if occupancy.
3. In smart daylight sensor function, natural light level lighter/lower than daylight setpoint to light off/on MUST keep at least 1mintue, that will turn off/on the light automatically.

About RESET and MODE(1,2,3,4)

The remote control comes with 4 Scene MODES which are not default. You may make desired parameters and save as the new MODE(1,2,3,4) to configure the installed sensors.

RESET: all settings go back to settings of DIP Switch in sensor.

SCENE MODES(1 2 3 4)

Application	Scene Options	Brightness	Detection Area	Hold Time	Stand-by Time	Stand-by Dim Level	Daylight Sensor
Indoor	Mode 1	100%	75%	5min	30min	30%	
Indoor	Mode 2	100%	75%	1min	+∞	30%	
Indoor	Mode 3	100%	75%	5min	30min	30%	30LUX
Outdoor	Mode 4	100%	75%	1min	+∞	30%	(30LUX/300LUX)

Change the MODES:

1. press / / / button, the remote control Led indicators show existing parameters.
2. press / / / to select the new parameters.
3. Press to confirm all parameters and saving in the mode.

UPLOAD

The upload function allows you to configure the sensor with all parameters in one operation. You may select CURRENT SETTING parameters or the MODE for uploading. Current setting parameters or the MODE are displayed in Remote control .

Upload the current parameters to sensor(s),and duplicate the sensor parameters form one to anther

1. Press button or press / / / , all parameters are displayed in Remote control.

Note: check if all parameters are correct , if not, change them.

2. Aim at the sensor and press button , the light that sensor connects will be on/off as confirm.

Note: if other sensor need same parameters, just aim at the sensor and press button.